

# KONKA<sup>®</sup>

LED TV

KUD65GT775AN

OWNER'S MANUAL

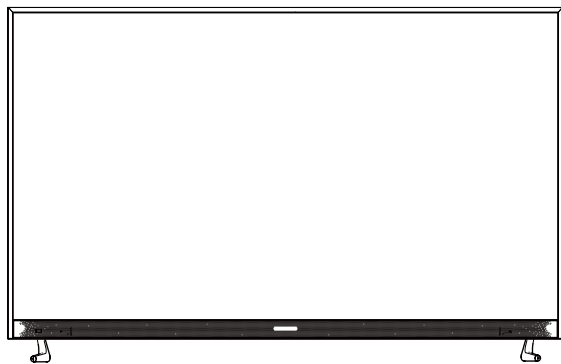

---

Please read this manual carefully before TV operation.  
Retain it for future reference.



# Important Safety Instructions and Maintenance

## Important Safety Instructions

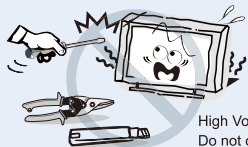

High Voltage  
Do not open

### CAUTION

Risk of electronic shock, do not open. Do not attempt to service this product yourself as opening or removing covers may expose you to dangerous voltage or other hazards. Refer all servicing to qualified service personnel.

To reduce the risk of fire or electric shock, do not expose this product to rain or moisture.

The apparatus shall not be exposed to dripping or splashing and no objects filled with liquids, such as vases, shall be placed on the apparatus.



The screen and cabinet get warm when the TV is in use. This is not a malfunction. In case of smoke, strange noise or strange smell from the unit:

- Turn off the power switch immediately;
- Disconnect the power plug from the power outlet;
- Contact your dealer or service centre. Never attempt to make repairs yourself because this could be dangerous.

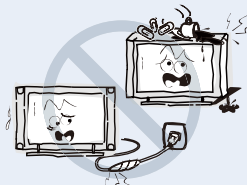
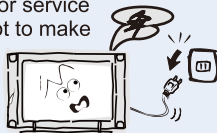

If the following problems occur:

Turn off the TV set and unplug the AC power cord immediately if any of the following problems occur. Ask your dealer or service centre to have it checked by qualified service personnel.

When:

- AC power cord is damaged.
- Poor fitting of AC power outlet.
- TV set is damaged by being dropped, hit or having something thrown at it.
- Any liquid or solid object falls through openings in the cabinet.

Never push objects of any kind into the set through the cabinet slots as they may touch dangerous voltage points or short-circuit parts that could result in a fire or electric shock. Never spill liquid of any kind on the set. Use special caution in households where children are present. The apparatus is not suitable for children under 3-year to operate.



Do not overload wall outlets, extension cords or adaptors beyond their capacity,

this can result in fire or electrical shock. Power-supply cords should be routed so that they are not likely to be walked on or pinched by items placed upon or against them, paying particular attention to cords at plug end, adaptors and the point where they exit from the appliance. The mains plug is used as the disconnect device. It shall remain readily accessible and should not be obstructed during intended use. Make sure to plug the power cord in until it is firmly inserted. When removing the power cord, make sure to hold the power plug when pulling the plug from the outlet, do not pull the plug out by the wire. NEVER touch the plug or power cord with wet hands. To disconnect the apparatus from the mains power, the plug must be pulled out from the mains socket, therefore make sure the mains plug is always easily accessible.

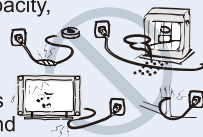

Do not push or scratch the front filter, or place any objects on top of the TV set. The image may be uneven or the screen may be damaged.

To avoid the fire, no naked flame source, such as lighted candles, should be placed on the apparatus.



# Important Safety Instructions and Maintenance

## Important Safety Instructions

An outside antenna system should not be located in the vicinity of overhead power lines or other electric light or power circuits, or where it can fall into such power lines or circuits. When installing an outside antenna system, extreme care should be taken to keep from touching such power lines or circuits as contact with them might be fatal. Ensuring the television is not overhanging the edge of the supporting furniture.

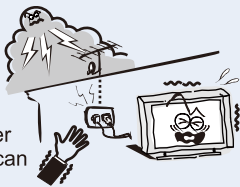

### When not in use

If you will not be using the TV set for several days, the TV set should be disconnected from the AC mains for environmental and safety reasons. As the TV set is not disconnected from the AC power when the TV is turned off at the standby switch, pull the plug from the AC power outlet to disconnect the TV completely. However, some TV sets may have features that require the TV set to be left in standby to function correctly. In the case of lightning, unplug the TV set from the outlet immediately. Never touch the antenna wire during lightning.



Do not pull the plug out by the wire; Never touch the plug with wet hands.

Excessive volume from earphones and headphones can cause hearing loss.



## Installation



The ventilation should not be impeded by covering the ventilation opening with items, such as newspapers, tablecloths, curtains, etc. At least 10 cm space should be left around the apparatus for sufficient ventilation.

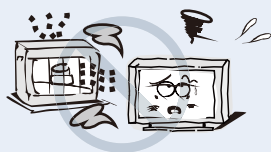

The product should be situated away from heat sources such as radiators, heat registers, stoves, or other products (including amplifiers) that produce heat. Place the apparatus in such a position that the screen is not exposed to direct sunlight. It is best to have soft indirect lighting while watching and avoid completely dark environments and reflection from the screen as these may cause eye fatigue. Keep the TV set away from any equipment emitting electromagnetic radiation.

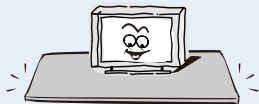

Do not place the set on an unstable cart, stand, table or shelf. The set may fall, causing serious personal injury as well as damage to the product. Use only with the cart, stand, tripod, bracket, or table specified by the manufacturer, or sold with the apparatus. An appliance and cart combination should be moved with care. Quick stops, excessive force, and uneven surfaces may cause the appliance and cart combination to overturn.



Do not place this apparatus near water, for example, near a bath tub, wash bowl, kitchen sink, or laundry tub; in a wet basement; or a swimming pool; and the like;

# Important Safety Instructions and Maintenance

## Installation



When the TV being moved in from cold place, it needs some right time for dew inside unit evaporating fully before turn on the unit;



To prevent injury, this apparatus must be securely attached to the floor/wall in accordance with the installation instructions.

## LED Screen

Although the LED screen is made with high precision technology and 99.99% or more of the pixels are effective, black dots may appear or bright points of light (red, blue or green) may appear constantly on the LED screen. This is a structural property of the LED screen and is not a malfunction. If the surface of the LED panel cracks, do not touch it until you have unplugged the AC power cord. Otherwise electric shock may result. Do not throw anything at the TV set. The LED panel may break from the impact and cause serious injury.

## Precautions When Displaying a Still Image

A still image may cause permanent damage to the TV screen.

Do not display still images and partially still images on the LED panel for more than 2 hours as it can cause screen image retention. This image retention is also known as "screen burn". To avoid such image retention, reduce the degree of brightness and contrast of the screen when displaying a still image.

Watching the LED TV in 4:3 format for a long period of time may leave traces of borders displayed on the left, right and centre of the screen caused by the difference of light emission on the screen. Playing a DVD or a game console may cause a similar effect to the screen.

Damages caused by the above effect are not covered by the Warranty.

Displaying still images from Video games and PC for longer than a certain period of time may produce partial after-images. To prevent this effect, reduce the 'brightness' and 'contrast' when displaying still images.

## Cleaning

Cleaning and handling the screen surface and cabinet. Disconnect the unit from the AC outlet before cleaning. To remove dust, wipe gently with a soft, lint free cloth. If required use a slightly damp cloth.



## MAINS PLUG

Wipe the mains plug with a dry cloth at regular intervals. Moisture and dust may lead to fire or electrical shock.

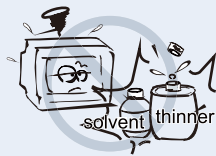
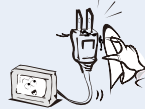

Use care not to subject the TV's surfaces to detergent. (A liquid inside the TV could lead to product failure, fire or electrical shock.) Use care not to subject surfaces to bug repellent, solvent, thinner, or other volatile substances as this may deteriorate the surface and finish of the cabinet.

Attention should be drawn to the environmental aspects of battery disposal;

This equipment is a Class II or double insulated electrical appliance. It has been designed in such a way that it does not require a safety connection to electrical earth.



## Important Information

If a television is not positioned in a sufficiently stable location, it can be potentially hazardous due to falling. Many injuries, particularly to children, can be avoided by taking simple precautions such as:

- Using cabinets or stands recommended by the manufacturer of the television.
- Only using furniture that can safely support the television.
- Ensuring the television is not overhanging the edge of the supporting furniture.
- Not placing the television on tall furniture (for example, cupboards or bookcases) without anchoring both the furniture and the television to a suitable support.
- Not standing the televisions on cloth or other materials placed between the television and supporting furniture.
- Educating children about the dangers of climbing on furniture to reach the television or its controls.
- Keep small accessories out of reach of children so they are not mistakenly swallowed.

## Table of Contents

<b>Accessories</b> .....	5
<b>Introduction</b> .....	6
Features.....	6
Specifications.....	7
<b>Stand and wall-mounting instructions (optional)</b> .....	8
<b>General Description</b> .....	9
Overview of back panel.....	9
Overview of front panel.....	10
Overview of remote control.....	11
Installing Batteries in the Remote Control.....	14
<b>External Connection</b> .....	14
Antenna connection.....	14
Connecting VCR.....	15
Connecting a Camcorder.....	16
Connecting DVD Player/Set-Top Box via HDMI.....	17
Connecting Digital Audio System.....	18
Connecting PC.....	19
<b>Supporting signals</b> .....	19
<b>Basic operation</b> .....	20
Menu Operation.....	20
<b>Menu system instruction</b> .....	22
Picture.....	22
Sound.....	23
Setting.....	25
Lock.....	27
PVR Option.....	28
Program.....	30
Network.....	32
About.....	33
<b>Home Operation</b> .....	35
SOURCE setup.....	35
APP setup.....	35
SETTING setup.....	38
<b>Digital Media Player</b> .....	39
<b>Troubleshooting</b> .....	40

## Accessories

Please make sure the following items are included with your LED TV. If any items are missing, contact your dealer.



Remote Control

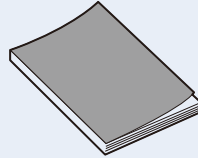

Owner's  
Instructions

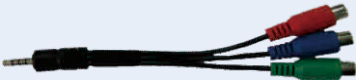

Mini YPbPr Cable



Mini AUDIO Cable

# Introduction

## Features

- TV adopts 65" TFT LED display screen
- Zero X radiation complies to green environment protection requirement
- Connect to computer directly to realize TV/monitor combo.
- USB 2.0
- 16:9 wide screen
- Auto tuning and fine tuning
- HDMI input
- Component Compatible (480i; 480P; 576i; 576P; 720P; 1080i; 1080P)
- PC VGA
- Programmable sleep timer
- Wide range voltage input
- No-signal automatic power off

## Basic Functions

### **Input terminals used for external equipment connection**

- 2 x USB inputs
- 2 x HDMI inputs
- 1 x COMPONENT input
- 1 x AV input
- 1 x SPDIF output
- 1 x Headphone output
- 1 x DVB-S input
- 1 x RJ-45 NET
- 1 x CI input
- 1 x PC VGA input
- 1 x RF input



# Introduction

## Specifications

Model	KUD65GT775AN	
Display size	65" Diagonal (max.)	
LED panel resolution	3840x2160	
Speaker output power	≥ 12Wx2	
Power supply	110-240V~, 50/60Hz	
TV receive system	Digital: DVB-T/T2, DVB-C, DVB-S/S2 Analog: PAL: BG, I, DK, SECAM: BG, D/K	
Frequency range	Analog: Antenna: 46.25MHz-855.25MHz Digital: DVB-T/T2: 5-12,21-69 DVB-C: 113MHz~898MHz DVB-S/S2: 950MHz-2150MHz	
Video in	PAL/NTSC/SECAM	
Power consumption	230W	
Standby consumption	≤ 1W	
Antenna input	75 ohms	
Controller power	DC 3V (Two AAA size batteries)	
Dimensions (LxWxH)	TV with stand	1452x363.5x912.5mm
	TV without stand	1452x72.2x865.8mm
Weight (Net weight)	TV with stand	22.7Kg
	TV without stand	22 Kg
Work temperature	0°C-40°C	

### NOTES:

- Design and specifications are subject to change without notice.
- Weight and Dimension shown are approximate.

## Stand and wall-mounting instructions (optional)

How to assemble the stand

If you need to remove or assemble the stand please read the following instructions.

- Before attaching/detaching the stand, make sure to turn off the TV.
- Before performing work, spread cushioning over the base area to lay the LED TV on. This will prevent it from being damaged.

Assembling instruction:

Put the television on the table, fix the stands with four screws given in the carton.

Step1: Take out two stands from package, and insert them into bottom of TV;

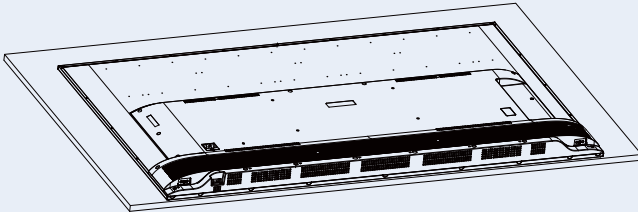

Step2: Take out four screws provided with TV set and tighten them into screw holes;

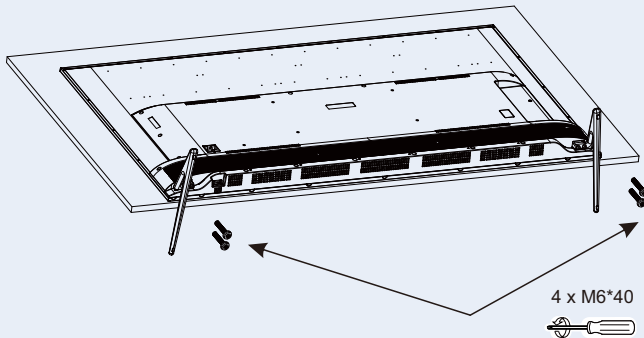

- To disconnect the stand from the TV, perform the above steps in reverse order.

Note:

The product and illustrations in this user's manual is only for explanation purposes and may vary depending on model.

# General Description

## Overview of back panel

You can connect the TV with video devices such as DVD/VCD player, VCR and video camera to enjoy the high quality picture.

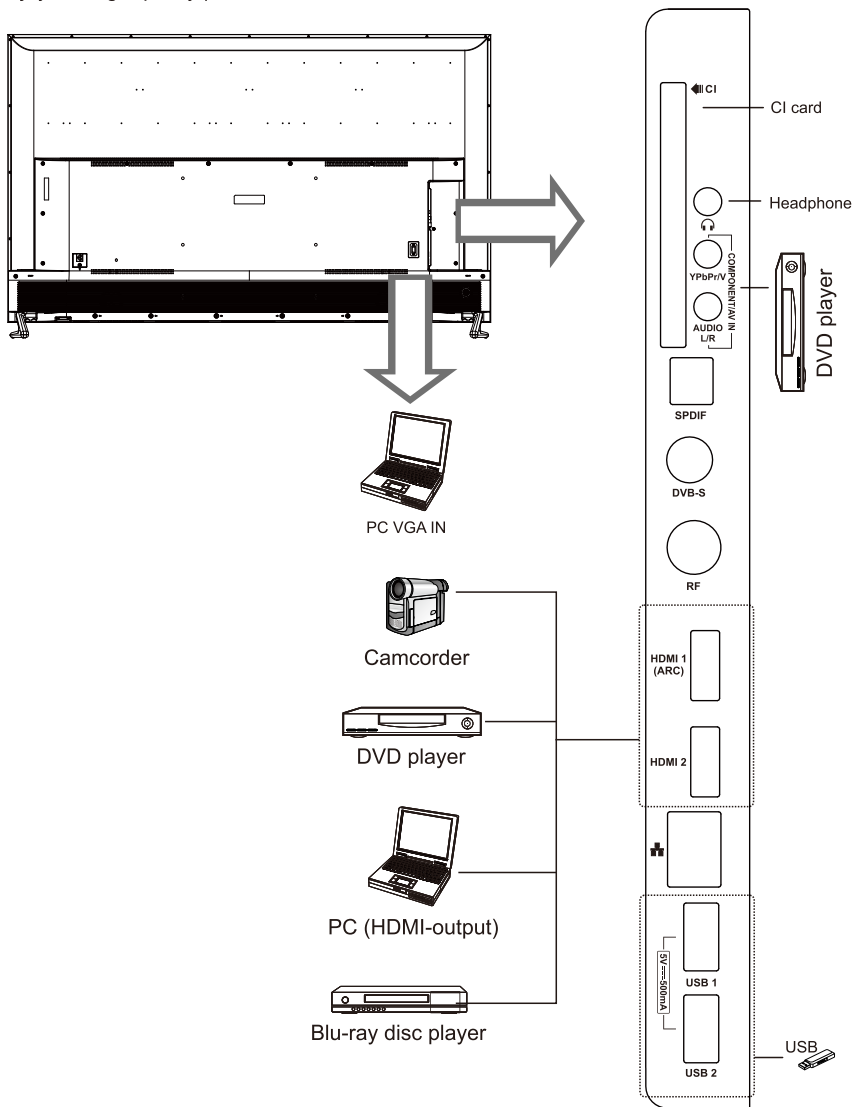

**Note:**

The product and illustrations in this user's manual is only for explanation purposes and may vary depending on model.

# General Description

## Overview of front panel

The buttons on the lower-right panel control your TV's basic features, including the on-screen menu. To use the more advanced features, you must use the remote control.

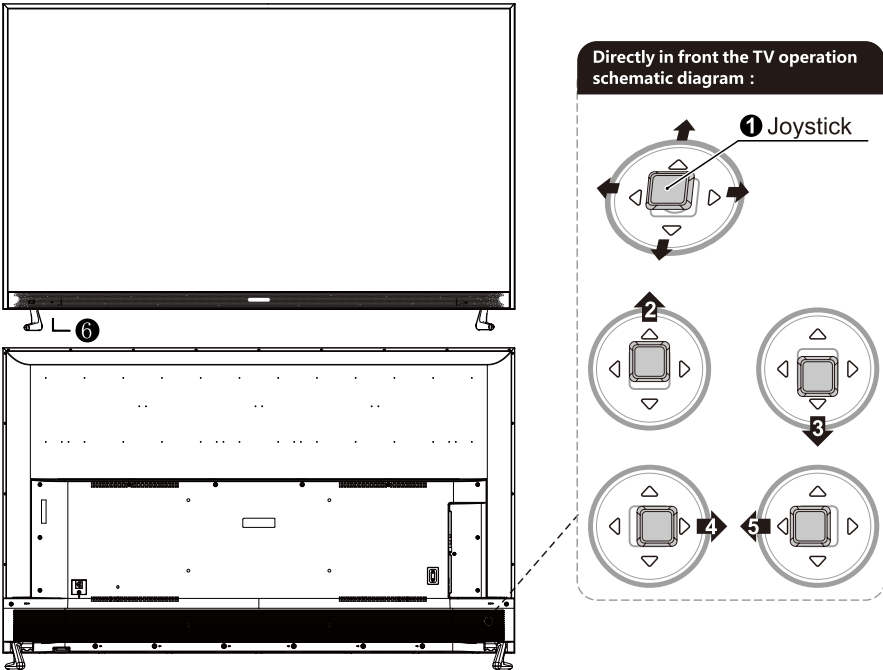

- 1** □ Centre Press this button on the control panel one time as CONFIRM at any menu.  
Press and hold this button to display FUNCTION menu at any menu.  
Press and hold this button to turn on TV when it is in standby mode.

---

- 2** ↑ Up Push one time: Use to select menu item if menu on TV. Use to go to last channel when watching TV.

---

- 3** ↓ Down Push one time: Use to select the next menu item if menu on TV. Use to go to next channel when watching TV. Push and hold this button to return to the last page.

---

- 4** ← Right Push one time: Use to select the left menu item if menu on TV. Use to increase volume when watching TV.

---

- 5** → Left Push one time: Use to select the right menu item if menu on TV. Use to decrease volume when watching TV.

---

- 6** REMOTE CONTROL SENSOR/POWER INDICATOR

---

# General Description

## Overview of Remote Control

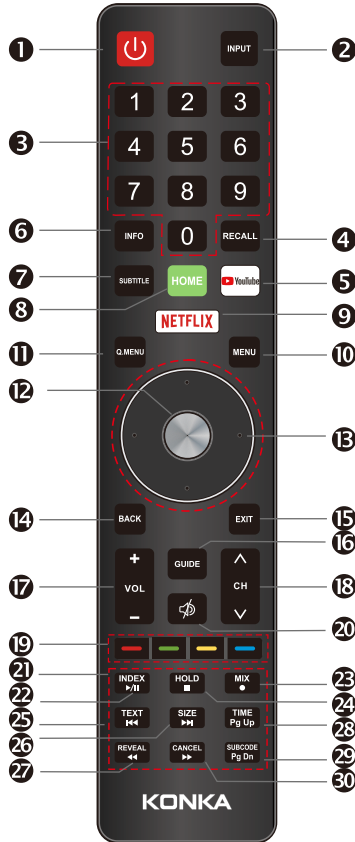

Loading batteries:

- 1) Remove the lid of the battery compartment.
- 2) Insert 2 size AAA batteries with polarities as indicated inside the compartment.
- 3) Replace the lid.

Note:

- 1) A loading of batteries should be last one year under normal use.
- 2) If you don't intend to use the remote control for a long period of time, remove batteries to avoid damage due to leakage.
- 3) Do not mix old and new batteries or different types.
- 4) Do not throw batteries into fire or water.
- 5) The batteries (battery pack or batteries installed) should not be exposed to excessive heat such as sunshine, fire or the like.

# General Description

## Overview of Remote Control

1. **POWER:** Turn the TV on and off.
2. **INPUT:** This button is used to switch among different sources, Select a source and press ENTER button to confirm.
3. **Digital Buttons(0-9):** Directly select channel with digital buttons.
4. **RECALL:** Switch to the previous program.
5. **YouTube:** If network connects, press this key to view YouTube directly.
6. **INFO:** Display the program information.
7. **SUBTITLE:** In DTV source, the button is used for subtitle language. In USB source, the button is used to change subtitle.
8. **HOME:** Press it to go to App home page.
9. **NETFLIX:** If network connects, press this key to view NETFLIX directly.
10. **MENU:** Display the main menu or exit the current menu.
11. **Q.MENU:** Press this key to go to quick menu.
12. **ENTER LIST:** Press this button to display a channel list, or confirm your selection.
13. **Arrow buttons ▲▼◀▶:** Use to select on-screen menu items and change menu values.
14. **BACK:** Return.
15. **EXIT:** Exit the menu.
16. **GUIDE:** Display menu GUIDE in DTV mode.
17. **VOL+/-:** Press these buttons to adjust the volume.
18. **CH▲/▼:** Press these buttons to change channel upward or downward.
19. **COLOR BUTTONS:** It's used in Apps.
20. **MUTE:** Press this button to cut off the sound of the TV set temporarily, press again to resume.

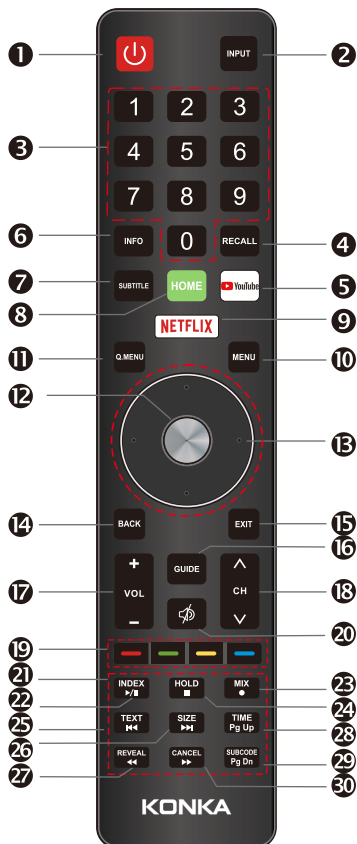

# General Description

## Overview of Remote Control

21. **DIGITAL MEDIA PLAYER CONTROL BUTTON:** Include play/pause, stop, previous, next, backward, forward is used in USB mode . Please refer to relevant instructions in the section of multimedia player.
22. **INDEX (▶/||):** Press INDEX button, then index page displays. It is also used for time shifting function when TV is on DTV mode, please refer to PVR page.
23. **MIX ( ● ):** Teletext buttons for mix function, please refer to TTX description page. It is also used for recording function when TV is on DTV mode, please refer to PVR page.
24. **HOLD:** Press HOLD button to toggle Hold function on or off. When Hold is switched on, the page acquisition is stopped. When Hold is switched off, the page acquisition is started.
25. **TEXT:** Press TEXT button to enter or exit teletext mode.
26. **SIZE:** Press SIZE button one time to display the upper half of the screen in double height, press the SIZE button two times to display the lower half of the screen in double height, press three times to display the full screen in normal size.
27. **REVEAL:** Pressing this button will reveal any hidden data (answers to quizzes for example). Press the REVEAL button again to return to normal screen.
28. **TIME:** This button is used to show the time of the teletext.
29. **SUBCODE:** Subcode mode gives the possibility to select certain subcode pages of a Teletext page. Entry of digits within the range 0...9 for current subcode entry. If the digit completes the entry, a page request is started. Press CH ▲ and CH ▼ buttons to change the subcode pages.
30. **CANCEL:** The CANCEL button will exit from any Teletext on the display. Press CANCEL button again to exit Teletext and return to live TV broadcast.

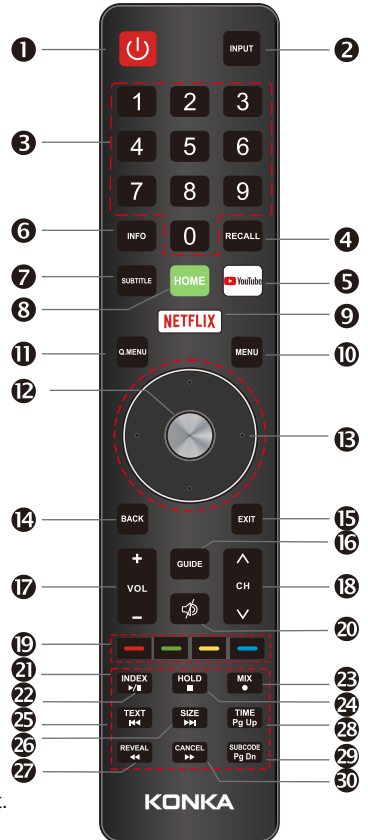

# General Description

## Installing Batteries in the Remote Control

### Installing Batteries

- 1** Open the battery compartment cover on the back side.

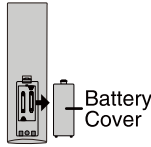

- 2** Insert two 1.5V AAA size batteries in correct polarity. Don't mix old or used batteries with new ones.

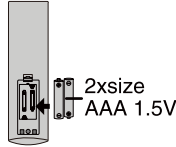

- 3** Closed the cover.

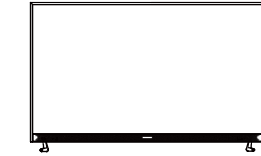
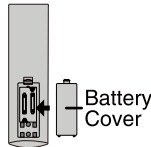

- † Point the remote towards the remote control sensor of the TV and use it within 8 meters.

- † Put the used batteries into the recycling bin since they can negatively affect the environment.

### NOTES:

- One loading of batteries will last for 1 year under normal use.
- If you do not intend to use the remote controller for a long period of time, remove them to avoid damage due to leakage.
- Do not use old and new batteries together.
- The batteries (battery pack or batteries installed) shall not exposed to excessive heat such as sunshine, fire or the like.

## External Connection

### Antenna connection

Antenna input impedance of this unit is 75ohm. VHF/UHF 75ohm coaxial cable can be connected to the antenna jack directly, if the antenna cable is 300ohm parallel flat feeder cable, you need to use the 300ohm/75ohm converter to connect the antenna cable to the antenna jack. For details Please refer to the following drawing.

#### Antennas with 300 Ω flat twins Leads

Use a 75ohm - 300ohm converter

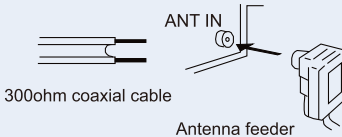

#### Antennas with 75 Ω Round Leads

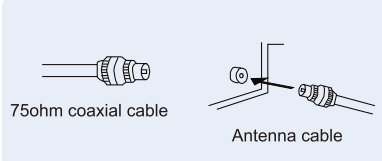



# External Connection

## Connecting VCR

These instructions assume that you have already connected your TV to an antenna or a cable TV system. Skip step 1 if you have not yet connected to an antenna or a cable system.

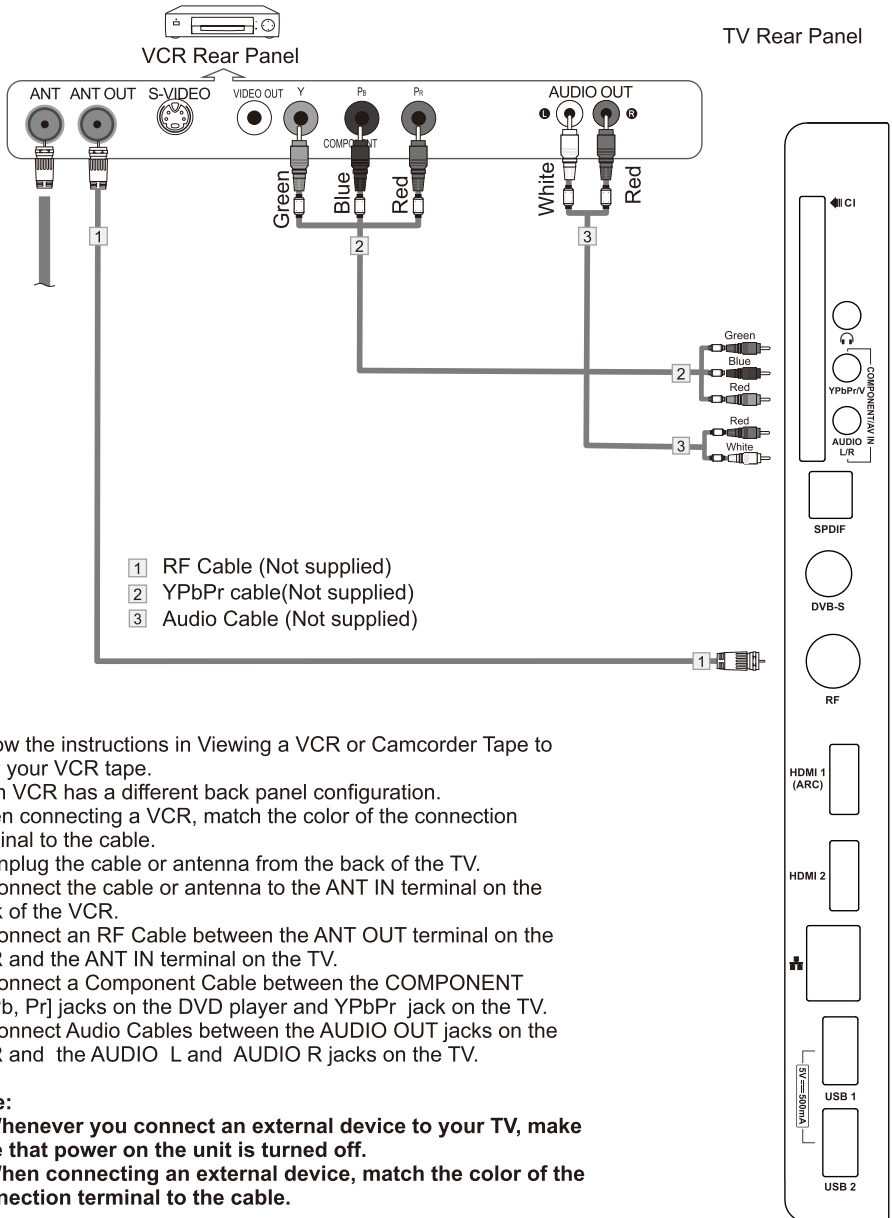

Follow the instructions in Viewing a VCR or Camcorder Tape to view your VCR tape.

Each VCR has a different back panel configuration.

When connecting a VCR, match the color of the connection terminal to the cable.

1. Unplug the cable or antenna from the back of the TV.
2. Connect the cable or antenna to the ANT IN terminal on the back of the VCR.
3. Connect an RF Cable between the ANT OUT terminal on the VCR and the ANT IN terminal on the TV.
4. Connect a Component Cable between the COMPONENT [Y, Pb, Pr] jacks on the DVD player and YPbPr jack on the TV.
5. Connect Audio Cables between the AUDIO OUT jacks on the VCR and the AUDIO L and AUDIO R jacks on the TV.

### Note:

1. Whenever you connect an external device to your TV, make sure that power on the unit is turned off.
2. When connecting an external device, match the color of the connection terminal to the cable.

# External Connection

## Connecting a Camcorder

The rear panel jacks on your TV make it easy to connect a camcorder to your TV. They allow you to view the camcorder tapes without using a VCR.

Each Camcorder has a different back panel configuration.

When connecting a Camcorder or DVD, match the color of the connection terminal to the cable.

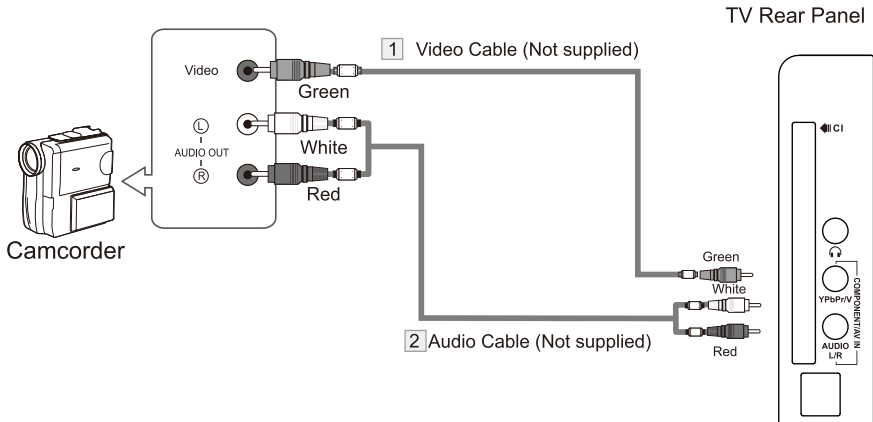

1. Connect a Video Cable between the AV VIDEO IN jacks on the TV and the VIDEO OUT jack on the camcorder.
2. Connect Audio Cables between the AUDIO L and AUDIO R jacks on the TV and the AUDIO OUT jacks on the camcorder.
3. Connect a Video Cable between the AV VIDEO IN jacks on the TV and the VIDEO OUT jack on the DVD.
4. Connect Audio Cables between the component IN AUDIO L and R jacks on the TV and the AUDIO OUT jack on the DVD.

### Notes:

1. Whenever you connect an external device to your TV, make sure that power on the unit is turned off.
2. When connecting an external device, match the color of the connection terminal to the cable.

# External Connection

## Connecting DVD Player/Set-Top Box via HDMI

This connection can only be made if there is a HDMI Output connector on the external device.

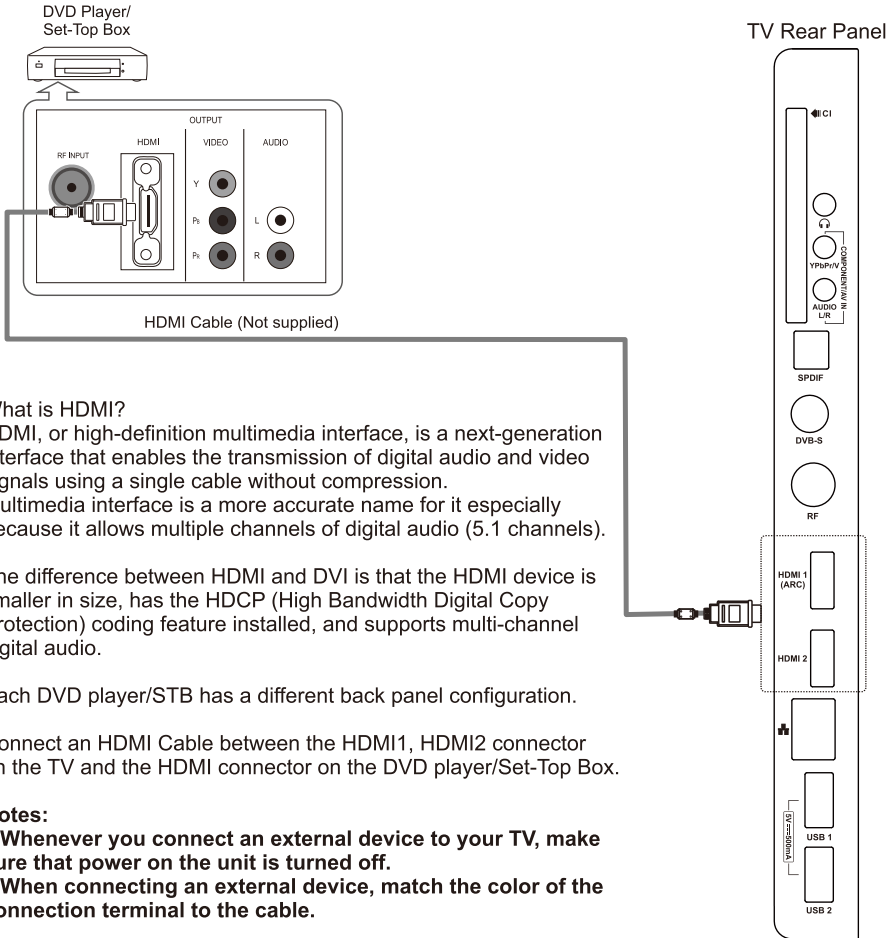

### What is HDMI?

HDMI, or high-definition multimedia interface, is a next-generation interface that enables the transmission of digital audio and video signals using a single cable without compression. Multimedia interface is a more accurate name for it especially because it allows multiple channels of digital audio (5.1 channels).

The difference between HDMI and DVI is that the HDMI device is smaller in size, has the HDCP (High Bandwidth Digital Copy Protection) coding feature installed, and supports multi-channel digital audio.

Each DVD player/STB has a different back panel configuration.

Connect an HDMI Cable between the HDMI1, HDMI2 connector on the TV and the HDMI connector on the DVD player/Set-Top Box.

### Notes:

1. Whenever you connect an external device to your TV, make sure that power on the unit is turned off.
2. When connecting an external device, match the color of the connection terminal to the cable.

# External Connection

## Connecting Digital Audio System

The rear panel jacks on your TV make it easy to connect a Digital Audio System to your TV.

Digital Audio System

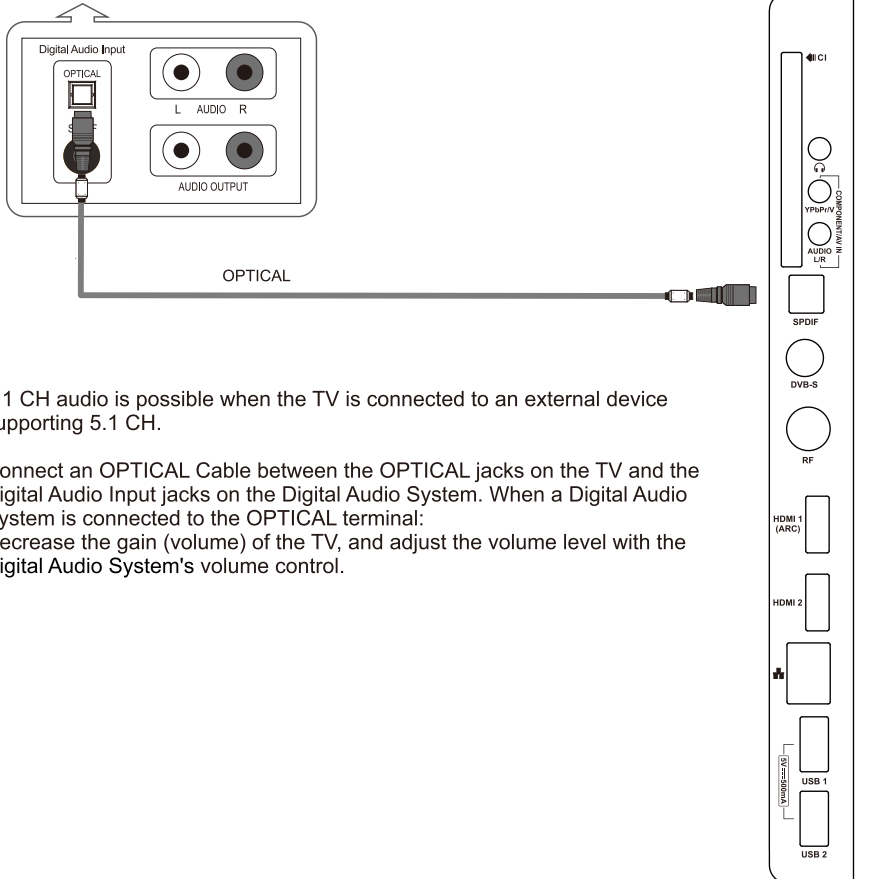

5.1 CH audio is possible when the TV is connected to an external device supporting 5.1 CH.

Connect an OPTICAL Cable between the OPTICAL jacks on the TV and the Digital Audio Input jacks on the Digital Audio System. When a Digital Audio System is connected to the OPTICAL terminal:  
Decrease the gain (volume) of the TV, and adjust the volume level with the Digital Audio System's volume control.

# External Connection

## Connecting PC

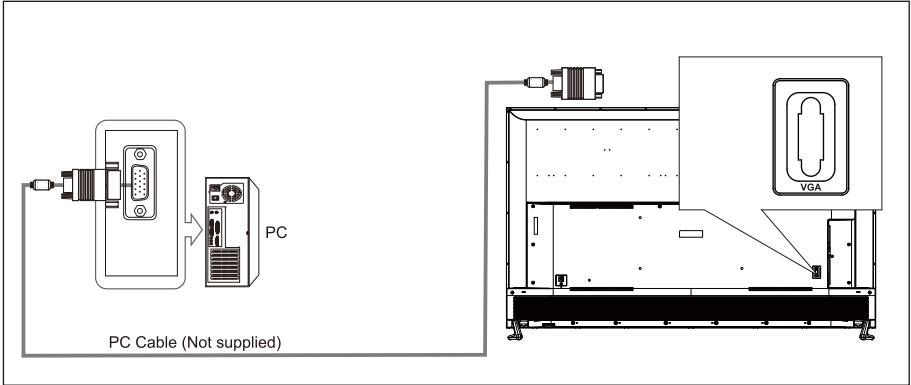

Each PC has a different back panel configuration.

Connect a PC Audio Cable between PC AUDIO IN jack on the TV and the Audio Out jack of the soundcard on your computer.

You should set PC software before you connect a PC to your TV (please refer to "PC Display" settings)

### Notes:

1. Whenever you connect an external device to your TV, make sure that power on the unit is turned off.
2. When connecting an external device, match the color of the connection terminal to the cable.

## Supporting Signals

Input	Mode
DTV	Digital: DVB-T/T2, DVB-C, DVB-S/S2
ATV	PAL BG I DK
	SECAM BG DK
CVBS	PAL/NTSC/SECAM

Input	Resolution	Vertical Frequency	
PC/VGA	VGA	640x480 60Hz	
	SVGA	800X600 60Hz	
	XGA	1024X768 60Hz	
	SXGA	1280X1024	60Hz
		1360X768	60Hz
		1920X1080	60Hz

Input	Resolution	Vertical Frequency
Component	480i	60Hz
	480p	60Hz
	576i	50Hz
	576p	50Hz
	720p	50Hz/60Hz
	1080i	50Hz/60Hz
	1080p	50Hz/60Hz
HDMI	480p	60Hz
	576p	50Hz
	720p	50Hz/60Hz
	1080i	50Hz/60Hz
	1080p	50Hz/60Hz
	3840x2160	24Hz/25Hz/30Hz/60Hz

# Basic Operation

## Menu Operation

### 1 Input Setup

Press **INPUT** key on the remote control to enter "INPUT SOURCE" menu.

Use **◀▶** key to select a input source and press **ENTER** key to confirm.

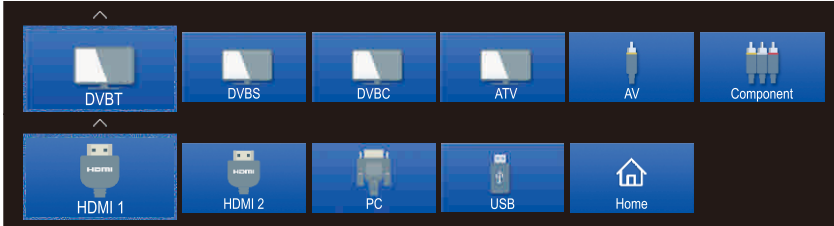

### 2 Channels Selection

There are four ways to select channel:

- 1) Using number keys, and "**ENTER**" keys on the remote control to select channel directly.

To select channel 90, press **9** → **0** → **ENTER** .

When you use the number buttons, you can directly select channels that were either erased or not memorized.

- 2) Using **CH** **◀▶** key on the remote control or on your TV to select channel.

When you press the **CH** **◀▶** key, the TV changes channels in sequence. You will see all the channels that the TV has memorized.

You will not see channels that were either erased or not memorized.

- 3) Press **RECALL** key to return to previous channel, press it again to return to current channel.

To quickly switch between two channels that are far apart, tune to one channel, then use the number keys to select the second channel. Then use the **RECALL** button to quickly alternate between them.

**RECALL** is not activated if no channel has been changed after TV turning on.

- 4) Select channels from "Channels List" or "Favorite List".

Press "**ENTER**" key to choose from "Channel List" menu.

### 3 Volume Adjustment and Mute Setup

#### Volume adjustment

Press **VOL+** / - key on the remote control or the TV to display "Volume" menu, adjust the volume of TV between 0 to 100 by using **VOL+** / -key:

# Basic Operation

## Menu Operation

- To increase the volume, press **VOL +** key;
- To decrease the volume, press **VOL -** key;

### Mute

Press "**MUTE**" and the sound cuts off. The MUTE icon will appear in the lower-right corner of the screen.

To resume sound, press the "**MUTE**" button again, or simply press the **VOL+** key.

## 4 Current Channel Information

Press "INFO" key on the remote control to view current channel information, the indications of channel information are listed in the following table.



Press "EXIT" key on the remote control to exit this OSD.

## 5 EPG Menu

Press **BACK/GUIDE** key to enter "EPG" menu, the first line displays current channel number, channel name, event title and current time.

The following line displays all programs which will be displayed in this channel, press **▲/▼** key to select the program you desired, then press "**ENTER**" key to enter this program to watch.

Reminder use "Reminder" (**ENTER**) button to reserve programs. If the TV is in DTV mode, it will automatically turn to the reserved program at the scheduled time. Press **◀** key and select "Schedule" option to look up the reminder list.

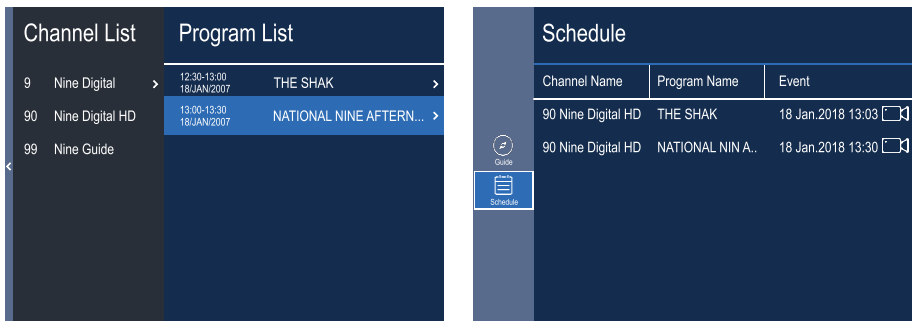

Press **EXIT** key on the remote control to exit this OSD.

# Menu system instruction

## Picture

1. Press **MENU** key to display the main menu on the screen.
2. Press **▲/▼** key to select "Picture" option.
3. Press **▶** key to enter "Picture" submenu.

### **Contrast**

Adjusts the lightness and darkness between objects and the background.

### **Brightness**

Adjusts the brightness of the picture.

### **Color**

Adjusts the colors, making them lighter or darker.

### **Sharpness**

Adjusts the outline of objects to either sharpen them or make them more dull.

### **Tint**

Adjusts the Tint of the picture.

### **Backlight**

You can Change the brightness of the entire screen according to your preference.

1. Press **▲/▼** key to select "Backlight" option.
2. Press **◀/▶** key to increase or decrease the backlight value.

- Backlight: Adjusts the brightness of the whole screen.

### **Color Temperature**

You can change the color of the entire screen according to your preference.

1. Press **▲/▼** key to select "Color Temperature" option.
2. Press **◀/▶** key to select one color temp.

### **Aspect Ratio**

1. Press **▲/▼** key to select "Aspect Ratio" option.
2. Press **◀/▶** key to change the size of the picture on the size of the picture on the screen.

### **Noise Reduction**

Press **▲/▼** key to select the Noise Reduction mode. You can select the right mode to match the pictures.

### **Open HDR**

1. Press **▲/▼** key to select "Open HDR" option.
2. Press **◀/▶** key to select "Auto", "Low", "Middle" or "High".

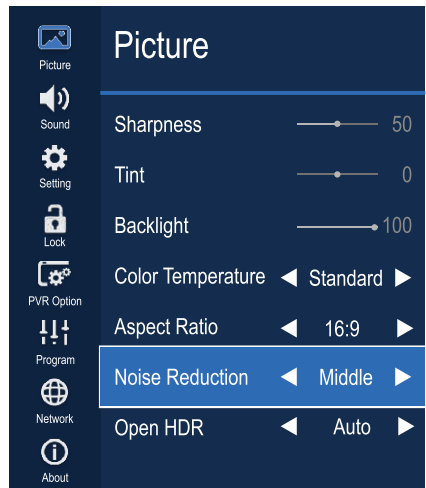



## Menu system instruction

### Sound

1. Press **MENU** key to display the main menu on the screen.
2. Press **▲/▼** key to select "Sound" option.
3. Press **▶** key to enter "Sound" submenu.

#### **Sound Mode**

You can select the type of the special sound effect to

be used when watching a given broadcast.

Your TV has five sound settings ("Standard", "Music", "Movie", "Sport", "User") that are preset at the factory.

1. Press **▲/▼** key to select "Sound Mode" option.
2. Press **◀/▶** key to select one sound mode.

- Standard: Selects the normal sound mode.
- Music: Provides clear and live sound for music.
- Movie: Provides live and full sound for movies.
- Sports: Emphasizes bass over other sounds.
- User: Selects your custom sound settings.

#### **Equalizer**

Set sound equalizer mode.

#### **Balance**

If the volumes of the left speaker and the right speaker are not the same, you can adjust the "Balance" to suit your personal preference.

1. Press **▲/▼** key to select "Balance" option.
2. Press **◀/▶** key to decrease or increase the value of the item.

#### **Auto Volume Limit**

Each broadcasting station has its own signal conditions, and it is inconvenient to adjust the volume every time the channel is changed. "AVL" automatically adjusts the volume of the desired channel by lowering the sound output when the modulation signal is high or by raising the sound output when the modulation signal is low.

1. Press **▲/▼** key to select "AVL" option.
2. Press **◀/▶** key to select "On" or "Off".

#### **Surround sound**

This is used to turn on surround sound to gain better sound effect.

1. Press **▲/▼** key to select "Surround sound" option.
2. Press **◀/▶** key to select "On" or "Off".

#### **Dolby Audio Process**

This is used to set DAP.

1. Press **▲/▼** key to select "Dolby Audio Process" option.
2. Press **◀/▶** key to select "On" or "Off".

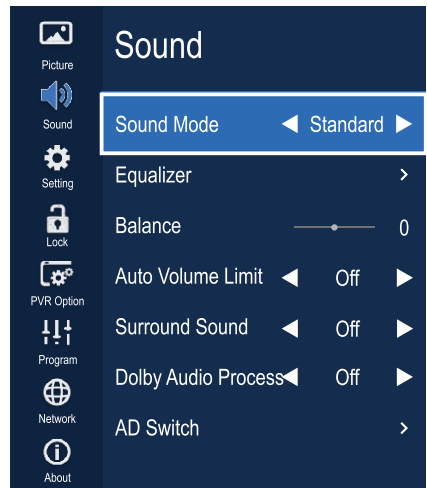

## Menu system instruction

### Sound

#### **AD Switch**

Press ▲/▼ button to select AD Switch, then press **ENTER** or ► button to enter sub-menu.

In it you can turn the AD Switch on or off and set the volume ratio in DTV mode.

#### **Digital Output Type**

This is used to set digital audio output.

1. Press ▲/▼ key to select "Digital Output Type" option.
2. Press ◀/▶ key to select a digital output type in DTV or HDMI mode.

#### **Audio Type**

This used to set audio type

1. Press ▲/▼ key to select "Audio Type" option.
2. Press ◀/▶ key to select audio type.

#### **Audio Delay**

This used to set audio type

1. Press ▲/▼ key to select "Audio Delay", then press **ENTER** or ► button to enter sub-menu.
2. Press ◀/▶ key to decrease or increase the value of the item.

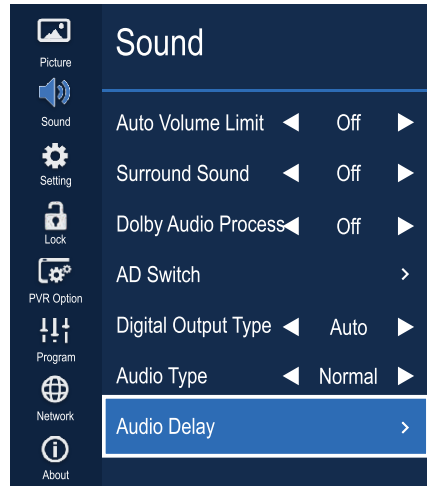

# Menu system instruction

## Setting

1. Press **MENU** key to display the main menu on the screen.
2. Press **▲/▼** key to select "Setting" option.
3. Press **▶** key to enter "Setting" submenu.

### Language

1. Press **▲/▼** key to select "OSD Language" setting.
2. Press **ENTER** or **▶** key to select a proper language for OSD.

### OSD Time

Set the preferred amount of time for the OSD to be displayed on the screen.

### HDMI EDID

This function is only used in HDMI mode.

1. Press **▲/▼** key to select "HDMI EDID" option.
2. Press **◀/▶** key to select "Auto", "2K" or "4K".

### HBBTV

This used to set HBBTV  
Turn on or turn off the HBBTV function.

### Link Setup

1. Press **▲/▼** key to select "Link Setup" option.
2. Press **▶** key to enter "Link Setup" submenu.

#### Link-CEC

Turn on or turn off the **Link-CEC** function.

#### HDMI ARC

Turn on or turn off the **HDMI ARC** function.

#### Auto Power

Turn on or turn off the **Auto Power** function.

#### Auto Standby

Turn on or turn off the **Auto Standby** function.

### Time

1. Press **MENU** key to display the main menu on the screen.
2. Press **▲/▼** key to select "Time" option.
3. Press **▶** key to enter "Time" submenu.

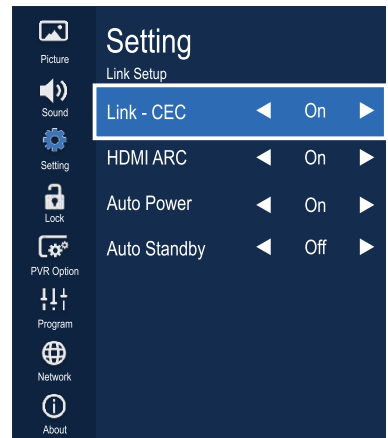
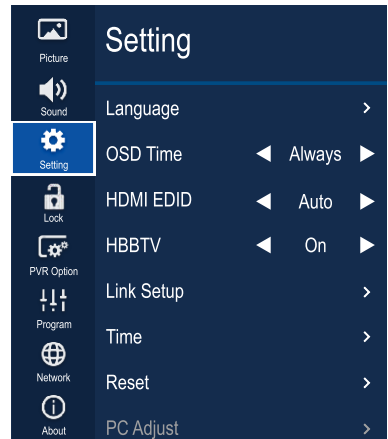

## Menu system instruction

### Setting

#### Auto Sync

You can modify the time of your TV set in Manual mode. In Auto mode, the "clock" is decided by the DTV signal. few minutes and don't turn off the power, it will turn off automatically when updating finish.

#### Clock --:--

When Auto Sync is on, the clock is got from DTV streams; Set the clock when Auto Sync is off.

#### Off Time

In "Off Time" item, press ► button or **ENTER** button to enter the submenu, set the day & time to turn off the TV set.

#### On Time

In "On Time" item, press ► button or **ENTER** button to enter the submenu, set the time to turn on the TV set, when the TV set is in the standby mode. You can also choose which day to control you TV set in a week.

#### Sleep Timer

1. Press ▲/▼ key to select "Sleep Timer" option.
2. Press ◀/▶ key repeatedly until the desired time appears (Off, 10mins, 20mins, 30mins, 60mins, 90mins, 120mins, 180mins, 240mins).

Notes: The sleep timer you have set will be cancelled when the TV turns off or if a power failure occurs.

Notes: When the time is less than 60 seconds, remind information will be displayed on the screen. Press any key button to cancel timer function.

#### Auto Sleep

Press ▲/▼ key to select whether to open the No signal Power off features. If this function is opened, the TV will power off when there is no signal.

#### Time Zone

You can choose it to modify your time zone in the TV set.

1. Press ▲/▼ key to select "Time Zone" option.
2. Press ◀/▶ key to select time zone.

#### Reset

1. Press "▲/▼" key to select "Reset" option.
2. Press "►" or "**ENTER**" key to confirm.
3. Press "Yes" to confirm again, TV will turn off automatically and change all setting to factory setting.

#### PC Adjust

This option is only used in VGA.

1. Press ▲/▼ key to select "PC Adjust" option.
2. Press "►" or **ENTER** key to enter the "PC Adjust" submenu.

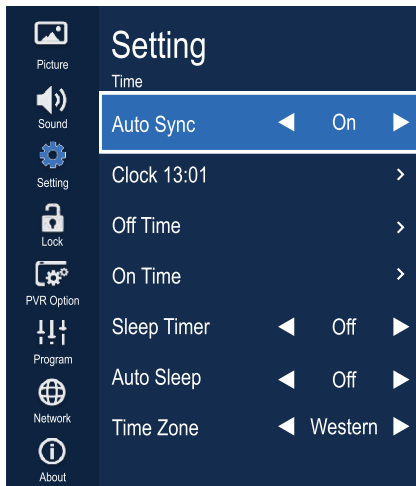

## Menu system instruction

### Lock

The "Lock" feature automatically locks out programming that is deemed inappropriate for children. The user must first enter a Password before any of the lock restrictions can be set up or changed.

1. Press **MENU** key to display the main menu on the screen.
2. Press **▲/▼** key to select "Lock" option.
3. Press **▶** key to enter "Lock" submenu, "Enter Password" menu will appear, enter your 4-digit password to enter "Lock" submenu (the default and universal password is 1980).

#### **Lock System**

Set the Lock function on or off.

1. Press **▲/▼** key to select "Lock System" option.
2. Press **◀/▶** key to select "On" or "Off".

#### **Set Password**

1. Press **▲/▼** key to select "Set Password" option.
2. Enter your 4-digit password to enter "Set Password" submenu.  
Choose any 4-digits for your new password and enter them. As soon as the 4 digits are entered, the cursor skipped to "Confirm Password" item, re-enter the same 4 digits, and your new password has been memorized.

When the programs is locked, you can also press the menu key, Info key and so on. Then you can press **◀/▶** key to call back the input-password window.

#### **Parental Guidance**

This option only used in DTV mode.

1. Press **▲/▼** key to select "Parental Guidance" option.
2. Press **◀/▶** key to select the lock level of the Parental Rate.

#### **CI CAM PIN Code**

Set CI CAM Pin Code Function.

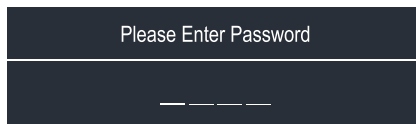
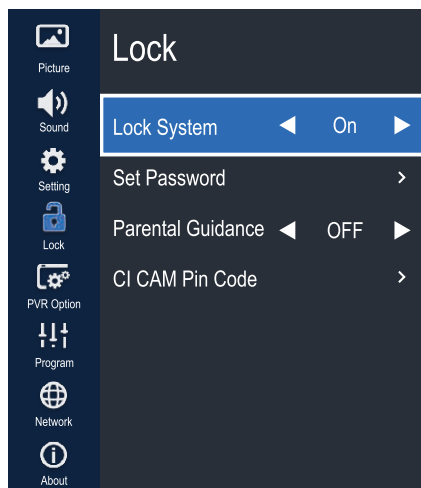

## Menu system instruction

### PVR Option

1. Press **MENU** key to display the main menu on the screen.
2. Press **▲/▼** key to select "PVR Option" option.
3. Press **▶** key to enter "PVR Option" submenu.

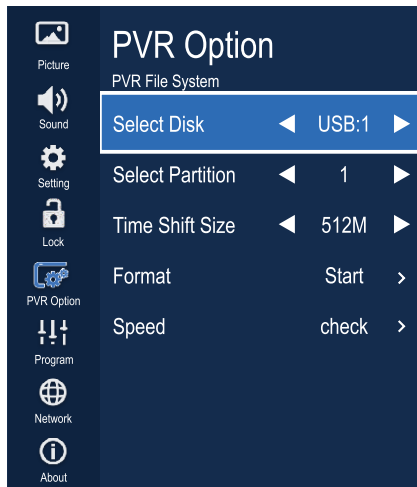

#### PVR File System

1. Press **▲/▼** key to select "PVR File System" option.
2. Press **ENTER** or **▶** key to enter submenu in DTV mode.

Connect the USB disk to the standard USB port before use PVR.

- Select Disk: Press "ENTER" button to enter submenu and press "◀/▶" to choose the disk for PVR.
- Time Shift Size: Display the buffer used for PVR.
- Format Start: Press "ENTER" button to enter format submenu.
- Speed: Display the disk writing/reading speed.

#### Warning:

1. The disk must be formatted when first used for PVR, so backup the original data in the disk. It's suggested use a special disk for PVR. Don't modify the PVR file in PC.
2. All the time is not precise, just for reference.

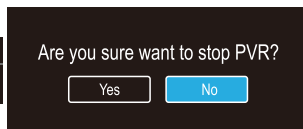

#### Start Record

Press **▲/▼** key to select "Start Record". If the storage device is ready, press **"ENTER"** key to start record.

The recording menus will disappear in 5 seconds, press **"ENTER** or **▲/▼/◀/▶"** key to recall them out. When recording, press **"■"** key again, then you can choose to stop recording or continue:

# Menu system instruction

## PVR Option

### Start Timeshift

In DTV channel, press “▶/⏸” key to pause, press it again to resume playback.

This is the “Time Shift”. During the suspension the image are temporarily stored in the disk, so programs will not miss the suspension period, the length of time may be suspended by the size of the disk buffer space constraints.



This feature supports fast forward and rewind function. Press “◀◀/▶▶” key to go backward or forward.



### Record Files

Press ▲/▼ key to select "Recorded List". If the storage device is ready, press “ENTER” key to check the record list.

- 1) Press ▲/▼ key to select record file.
- 1) Press ▶ and “ENTER” key to delete the selected file.

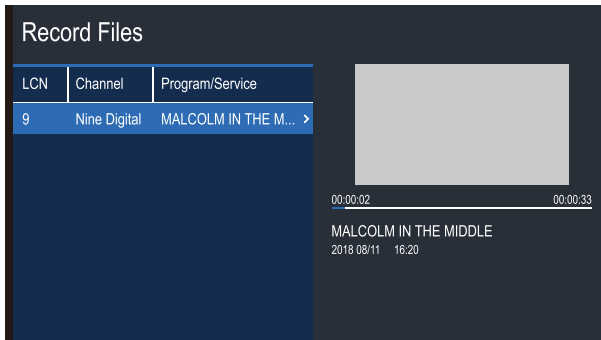

# Menu system instruction

## Program

1. Press **MENU** key to display the main menu on the screen.
2. Press **▲/▼** key to select "Program" option.
3. Press **▶** key to enter "Program" submenu.

### Auto Tuning

Press **▲/▼** key to select "Auto Tuning" option. The number of searched channels will be shown on the screen.

**Note:** If you want to exit the whole searching, you can press **EXIT** button.

### DTV Manual Tuning

You can use **◀/▶** button or input number to choose the channel. Then press **ENTER** button to search, the TV will store the DTV channel if there is a DTV signal present.

### ATV Manual Tuning

In the ATV/DTV source, you can choose "ATV Manual Tuning" to enter "ATV Manual Tuning" menu.

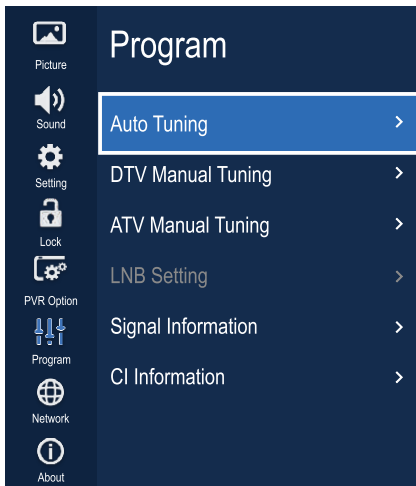

### Current CH

You can see the current channel number and you can press **◀/▶** button to choose the channel you want to modify. It will be searched and saved automatically.

### Color System

Select the "Color System" option, press **◀/▶** on the remote control to change. The color system will be changed repeatedly in the order: PAL-N, PAL-M, NTSC or AUTO.

### Fine Tune

In case of unfavorable image or sound of TV program, you can use "Fine Tune".

### Frequency

You can see the frequency of the searched channels.

### Save

You can see the channel you choosed.

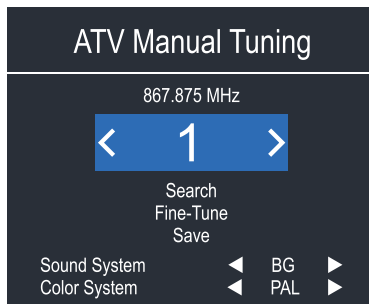
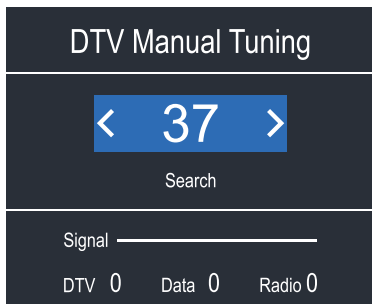



# Menu system instruction

## Program

### LNB Setting

This is used to set up DVBS parameter.

### Signal Information (Used only in DTV)

1. Press ▲/▼ key to select "Signal Information" option.
2. Press "ENTER" or ► key, you can see the information of the DTV channel.

### NOTE:

*Signal Quality/Signal Strength (DTV Only): Unlike analogue channels, which can vary in reception quality, digital channels must have perfect reception quality or you will not receive them at all. So, unlike analogue channels, you are not able fine tune a digital channel. If the signal strength indicates that the signal is weak, a possible solution is to adjust your antenna to increase the signal strength. Continue to adjust the antenna until you find the best position with the strongest signal.*

### CI Information

CI information function.

Program	
Signal Information	
Channel:	9
Name:	Nine Digital
Modulation:	64QAM
Quality:	100
Strength:	0

# Menu system instruction

## Network

1. Press **MENU** key to display the main menu on the screen.
2. Press **▲/▼** key to select "Network" option.
3. Press **▶** key to enter "Network" submenu.

### Wi-Fi

When the Wi-Fi wireless network is going to be used, if select auto scan, select "Auto Scan" option and press **▼** key to select your Wi-Fi network, then enter password to connect your Wi-Fi network.

If select manual input, select "Manual Input" option, then setting up the IP, Netmask, Gateway and DNS in sequence. When the setting complete, press the "Connect" option.

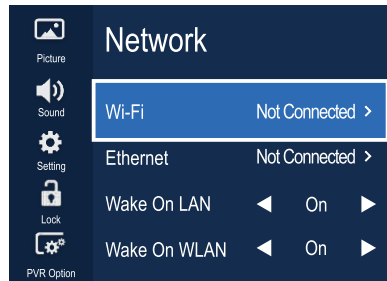

### Ethernet

When the wired network is used, if select dynamic IP address setting, pitch on the "DHCP" in the "Configuration", and press the "Connect" button to enter. If select static IP address setting, pitch on the "Static" in the "Configuration", then setting up the IP, Netmask, Gateway and DNS in sequence. When the setting complete, press the "Connect".

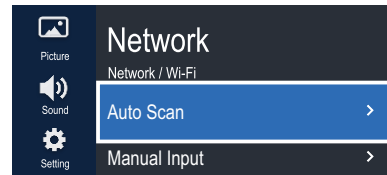

### Wake On LAN/Wake On WLAN

Set the mobile phone to enter the same network segment as the TV. When the mobile phone enters Youtube, you will find a push icon in the upper right corner. After clicking, you can search for the TV, and then push to wake up the TV.

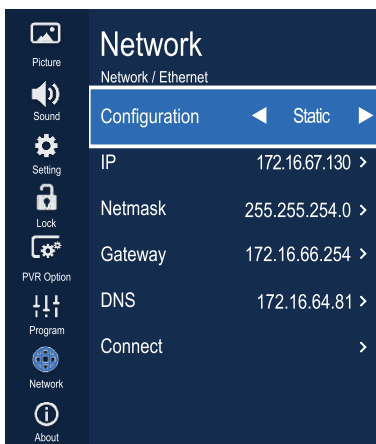
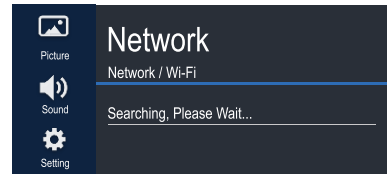

# Menu system instruction

## About

1. Press **MENU** key to display the main menu on the screen.
2. Press **▲/▼** key to select "About" option.
3. Press **▶** key to enter "About" submenu.

### Netflix

#### Netflix Deactive

1. Press **▲/▼** key to select "Netflix Deactive" option.
2. Press **▶** or **ENTER** key to confirm.
3. Press "YES" to confirm again, the Netflix will be activated.

#### Terminate Netflix

1. Press **▲/▼** key to select "Terminate Netflix" option.
2. Press **▶** or **ENTER** key to confirm.
3. Press "YES" to confirm again, the Netflix will be terminated.

#### Netflix ESN

Display the Netflix Esn information.

#### Netflix Version

Display the Netflix version.

### View End-User License Agreement

1. Press **▲/▼** key to select "View End-User License Agreement" option.
2. Press **▶** or "ENTER" key to display View End-User License Agreement.

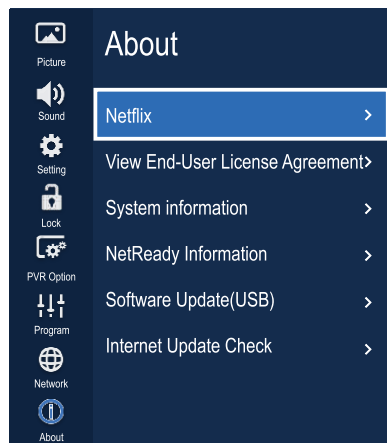
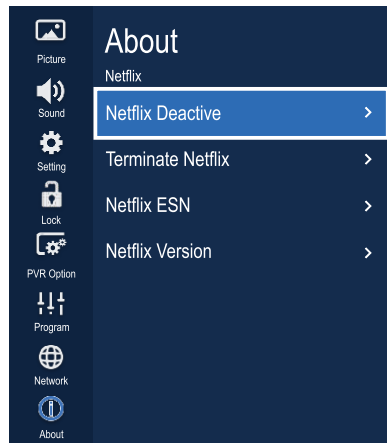

# Menu system instruction

## About

### ***System information***

- 1.Press ▲/▼ key to select "System information" option.
- 2.Press ► or "ENTER" key to display system information.

### ***Net Ready Information***

- 1.Press ▲/▼ key to select "Net Ready Information" option.
- 2.Press ► or "ENTER" key to display net ready information.

### ***Software Update(USB)***

When the TV need to be updated, please copy the new software to a USB storage to TV, then operating by following steps.

- 1.Press ▲/▼ key to select "Software Update" option.
- 2.Press ► or ENTER key to confirm.
- 3.Press "YES" to confirm again, the TV will update by USB. Please wait a few minutes and don't turn off the power, it will turn off automatically when updating is finish.

### ***Internet Update Check***

This can update TV through internet.

# Home Operation

## Setup wizard

Press "HOME" key to enter home interface.

## SOURCE setup

Press arrow key to select a input source and press **ENTER** key to confirm.

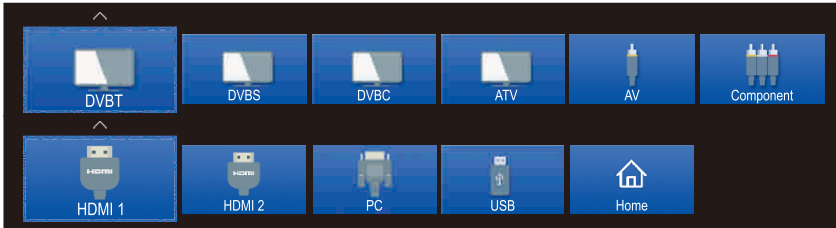

## APP setup



### 1) NETFLIX

- 1 Use arrow key to select  icon, then press "ENTER" key to enter NETFLIX.
- 2 Use arrow button to select one video and press "ENTER" key to play. Press "MENU" key to exit playing.
- 3 Use arrow key to browse the pages. press "MENU" key to return to main menu and press "EXIT" key to exit.

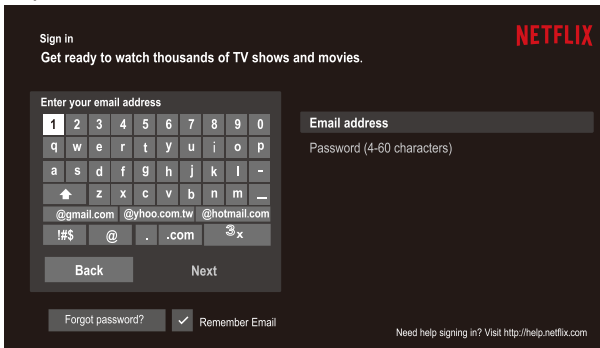

# Home Operation

## APP setup

### 2) Youtube



- 1 Use arrow key to select YouTube icon, then press "ENTER" key to enter Youtube.
- 2 Use arrow button to select one video and press "ENTER" key to play. Press "MENU" key to exit playing.

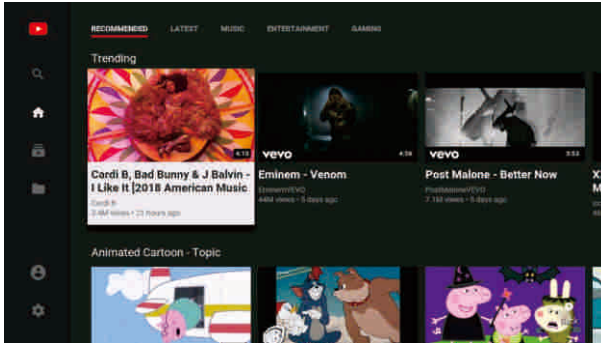

- 3 Press ▼ key to open or close control menu when playing.

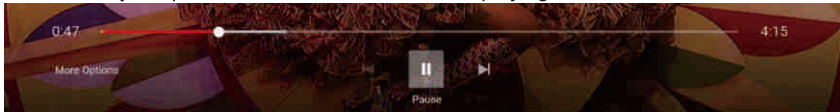

### 3) Facebook



- 1 Use arrow key to select facebook icon, then press "ENTER" key to enter Facebook.
- 2 Visit <https://www.facebook.com/device> on your smartphone or computer to get code and enter the code.
- 3 Press arrow key to browse the pages and press "ENTER" key to view.  
Press "BACK" key to return to main menu and press "EXIT" key to exit Facebook.

Red key: log in or log out Facebook.

Green key: refresh current page.

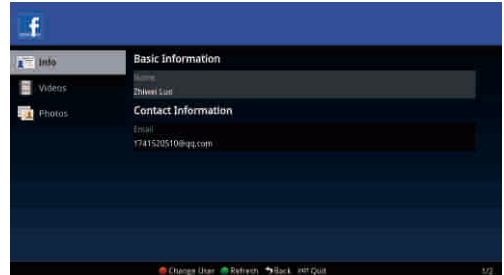
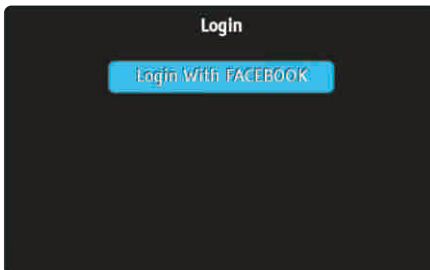

# Home Operation

## APP setup

### 4) Twitter

- ❶ Use arrow key to select  icon, then press “ENTER” key to enter Twitter.

**Authorize TVMessage to use your account?**



TVMessage  
By TVMessage  
widget.babao.com/  
A twitter client for Smart TV

User name or email

Password

**Authorise app**

This application will be able to:

- Read Tweets from your timeline.
- See who you follow, and follow new people.
- Update your profile.
- Post Tweets for you.
- Access your direct messages.

Will not be able to:

- See your email address.
- See your Twitter password.

- ❷ Input the right Email and password, then select “Authorize app” button and press “ENTER” key to log in.

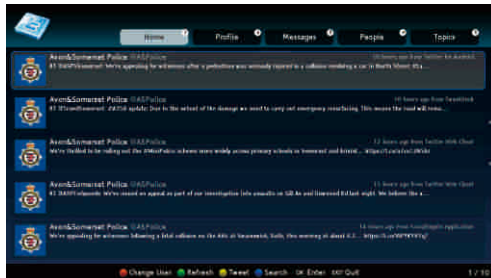

- ❸ Use arrow key to browse the pages. press “BACK” key to return to main menu and press “EXIT” key to exit twitter.

Red key: log in or log out twitter.  
Green key: refresh current page.  
Yellow key: write new twitter.  
Blue key: Search twitter.

# Home Operation

## APP setup

### 5) YAHOO Weather

- 1 Use arrow key to select  icon, then press "ENTER" key to enter YAHOO weather.
- 2 Input a city to get the weather information.

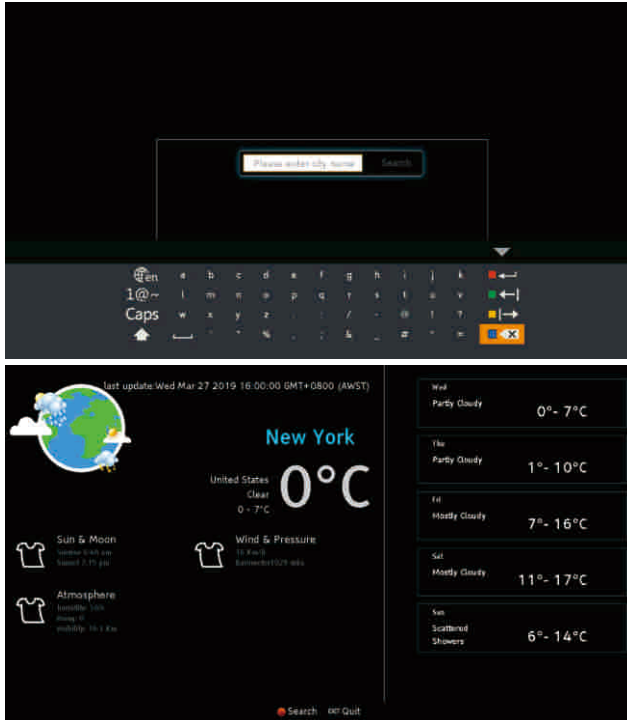

## SETTING setup

Press arrow key to adjust Picture, Sound, Setting, Lock, PVR Option, Program, Network or About.

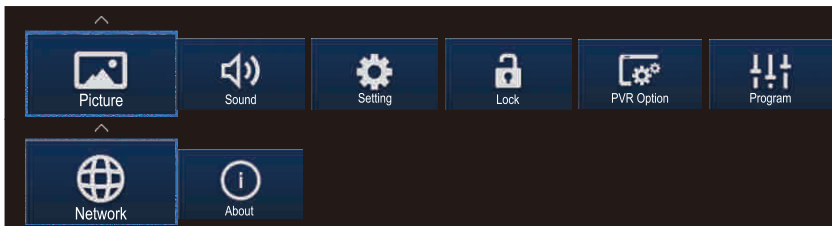



# Digital Media Player

## Introduction

This TV is embedded with one USB port digital media player. It can find the devices support USB1.1/2.0, including flash disk, USB hard disk and digital camera. It supports functions as: Display pictures. Play music files, Play video files.

### Notice:

1. In order to avoid affecting the user's viewing experience, please use the better quality and shorter USB cable.
2. Play, preview some of the non-standard files may appear abnormal, please understand.

### Explain:

1. Under the USB channel, you can use only the remote control.
2. Play Control menu to enter the playing surface to press the menu button pop-up menu

Data	Format
Picture	JPG, JPEG, PNG, BMP
Music	Mp3
Video	MPG, MPEG, Mp4, MKV, MOV

## Remote Control Button



### Description of Buttons:

Buttons	Function
AUDIO	Track switch (video)
SUBTITLE	Subtitle switch (video)
INFO	Show/Hide movie info (video)
CH ^	Page up
CH v	Page down
▶/	Play/Pause
■/•	Stop
◀◀	Previous file
▶▶	Next file
◀◀	Backward
▶▶	Forward

## Troubleshooting

If you have any problem, check the counter measures for each symptom listed below. The following symptoms may have been caused by inappropriate adjustment rather than actual malfunction of the unit. If the trouble persists, contact the Customer Care Centre, see back page for contact details.

Symptoms	Possible solutions
No power	Please check the power cord plugged in and that the power outlet works. Unplug the power cord and plug it in after 60 seconds and restart the TV.
No picture	Please check antenna connection. Station may be experiencing problems, please tune to another station. Please adjust the settings of contrast and brightness.
Good picture but no sound	Please increase the volume. Please check TV is under mute mode, press MUTE button on the remote control. Please check sound settings If external devices are being used, check their volumes are not set too low or turned off. If using AVI or Component inputs, please make sure cables are connected properly and not loose. If using DVI to HDMI cable, a separate audio cable is required. Make sure a headphone jack is not connected.
Good sound but abnormal color or no picture	Please check antenna connection and antenna condition. If using Component input, please check Component connections, incorrect or loose connections may cause colour problems or cause the screen to be blank.
No response to remote control	Batteries of remote control may have exhausted, if necessary, please change the batteries. Clean the remote control lens. The distance between LED TV and remote control should be within 8m, within recommended operating angle and path is free of obstructions.
Full screen flickering under VGA	V-HEIGHT value may be set too big, restart computer and enter safe mode, then set monitor parameters to correct value according to adjustment description.
Horizontal stripes under VGA	Sample phase may be deflected, adjust phase according to picture position.
Colored dots may be present on the screen	Although the LED screen is made with high-precision technology and 99.99% or more of the pixels are effective, black dots may appear or bright points of light (red, blue, or green) may appear constantly on the LED screen. This is a structural property of the LED screen and not a malfunction.
Picture is breaking up	Keep the TV away from noisy electrical sources such as cars, hair dryers, welders, and all optional equipment. Electrical atmospheric interference such as local or distant lightning storms may cause picture to break up. When installing optional equipment, leave some space between the optional equipment and the TV. Check the antenna and connection. Keep the antenna away from any power or input/output cables.

## Troubleshooting

After Auto Tuning only some channels are available	Check your area is covered by Digital Video Broadcasts. Try re-tuning or manually tuning missing channels. Check that you are using the correct antenna type.
Channel cannot be selected	Check if the channel has been blocked in the main menu settings.
USB not playing	Please check connecting USB cable and power supply is connected. Hard drive has not been formatted. Please make sure USB disk is compatible and the multimedia data formats are supported.
Picture is distorted, macroblock, small block, dots, pixelization, etc	Compression of video contents may cause distortion especially on fast moving pictures such as sports and action movies.
Noise from speaker	Check cable connections, make sure a video cable is not connected to an audio input. Low signal level may cause sound distortion.
TV turns off automatically	Check if the Off Timer is set to On in the Setup menu. Sleep Timer may have been enabled. If there is no signal for about 10 minutes ( 2 minutes in VGA) from an input, the TV will turn off. If connected to your PC, check your PC power settings. Make sure the AC power cord is plugged in securely to the wall outlet and the TV.
TV turns on automatically	Check if the On Timer is set to On in the Setup menu.
Picture is not shown in full screen	Black bars on each side will be shown on HD channels when displaying SD (4:3) contents. Black bars on Top & Bottom will be shown on movies that have aspect ratios different from your TV. Adjust picture size option on your external device or TV to full screen.

## WARNING

Never place a television set in an unstable location. A television set may fall, causing serious personal injury or death. Many injuries, particularly to children, can be avoided by taking simple precautions such as:

- Using cabinets or stands recommended by the manufacturer of the television set.
- Only using furniture that can safely support the television set.
- Ensuring the television set is not overhanging the edge of the supporting furniture.
- Not placing the television set on tall furniture (for example, cupboards or bookcases) without anchoring both the furniture and the television set to a suitable support.
- Not placing the television set on cloth or other materials that may be located between the television set and supporting furniture.
- Educating children about the dangers of climbing on furniture to reach the television set or its controls

If your existing television set is being retained and relocated, the same considerations as above should be applied.

The plug or appliance coupler is used as the disconnect device, the disconnect device shall remain readily operable.

**KONKA<sup>®</sup>**  
KONKA GROUP CO.,LTD.